

CMOS Micropower Phase-Locked Loop

■ CD4046B CMOS Micropower Phase-Locked Loop (PLL) consists of a low-power, linear voltage-controlled oscillator (VCO) and two different phase comparators having a common signal-input amplifier and a common comparator input. A 5.2-V zener diode is provided for supply regulation if necessary.

The CD4046B types are supplied in 16-lead hermetic dual-in-line ceramic packages (F3A suffix), 16-lead dual-in-line plastic packages (E suffix), 16-lead small-outline packages (NSR suffix), and 16-lead thin shrink small-outline packages (PW and PWR suffixes).

VCO Section

The VCO requires one external capacitor C1 and one or two external resistors (R1 or R1 and R2). Resistor R1 and capacitor C1 determine the frequency range of the VCO and resistor R2 enables the VCO to have a frequency offset if required. The high input impedance ($10^{12}\Omega$) of the VCO simplifies the design of low-pass filters by permitting the designer a wide choice of resistor-to-capacitor ratios. In order not to load the low-pass filter, a source-follower output of the VCO input voltage is provided at terminal 10 (DEMODULATED OUTPUT). If this terminal is used, a load resistor (R_S) of 10 k Ω or more should be connected from this terminal to VSS. If unused this terminal should be left open. The VCO can be connected either directly or through frequency dividers to the comparator input of the phase comparators. A full CMOS logic swing is available at the output of the VCO and allows direct coupling to CMOS frequency dividers such as the RCA-CD4024, CD4018, CD4020, CD4022, CD4029, and CD4059. One or more CD4018 (Presettable Divide-by-N Counter) or CD4029 (Presettable Up/Down Counter), or CD4059A (Programmable Divide-by-N Counter), together with the CD4046B (Phase-Locked Loop) can be used to build a micropower low-frequency synthesizer. A logic 0 on the INHIBIT input "enables" the VCO and the source follower, while a logic 1 "turns off" both to minimize stand-by power consumption.

MAXIMUM RATINGS, Absolute-Maximum Values:

DC SUPPLY-VOLTAGE RANGE, (V_{DD})	-0.5V to +20V
Voltages referenced to V_{SS} Terminal)	
INPUT VOLTAGE RANGE, ALL INPUTS	-0.5V to $V_{DD} + 0.5V$
DC INPUT CURRENT, ANY ONE INPUT	$\pm 10\mu A$
POWER DISSIPATION PER PACKAGE (P_D):	
For $T_A = -55^\circ C$ to $+100^\circ C$	500mW
For $T_A = +100^\circ C$ to $+125^\circ C$	Derate Linearly at 12mW/ $^\circ C$ to 200mW
DEVICE DISSIPATION PER OUTPUT TRANSISTOR	
FOR $T_A =$ FULL PACKAGE-TEMPERATURE RANGE (All Package Types)	100mW
OPERATING-TEMPERATURE RANGE (T_A)	$-55^\circ C$ to $+125^\circ C$
STORAGE TEMPERATURE RANGE (T_{stg})	$-65^\circ C$ to $+150^\circ C$
LEAD TEMPERATURE (DURING SOLDERING):	
At distance 1/16 \pm 1/32 inch (1.59 \pm 0.79mm) from case for 10s max	+265 $^\circ C$

Features:

- Very low power consumption: 70 μW (typ.) at VCO $f_o = 10$ kHz, $V_{DD} = 5$ V
- Operating frequency range up to 1.4 MHz (typ.) at $V_{DD} = 10$ V, $R1 = 5$ k Ω
- Low frequency drift: 0.04%/ $^\circ C$ (typ.) at $V_{DD} = 10$ V
- Choice of two phase comparators: Exclusive-OR network (I) Edge-controlled memory network with phase-pulse output for lock indication (II)
- High VCO linearity: <1% (typ.) at $V_{DD} = 10$ V
- VCO inhibit control for ON-OFF keying and ultra-low standby power consumption
- Source-follower output of VCO control input (Demod. output)
- Zener diode to assist supply regulation
- Standardized, symmetrical output characteristics
- 100% tested for quiescent current at 20 V
- 5-V, 10-V, and 15-V parametric ratings
- Meets all requirements of JEDEC Tentative Standard No. 13B, "Standard Specifications for Description of 'B' Series CMOS Devices"

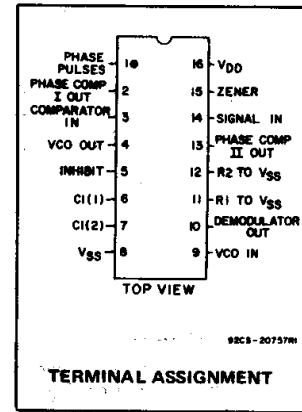

Applications:

- FM demodulator and modulator
- Frequency synthesis and multiplication
- Frequency discriminator
- Data synchronization
- Voltage-to-frequency conversion
- Tone decoding
- FSK - Modems
- Signal conditioning
- (See ICAN-6101) "RCA COS/MOS Phase-Locked Loop - A Versatile Building Block for Micropower Digital and Analog Applications"

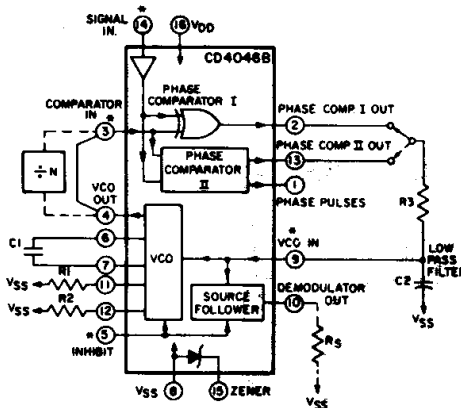
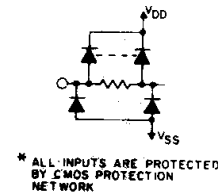

Fig.1 - CMOS phase-locked loop block diagram.



* ALL INPUTS ARE PROTECTED BY CMOS PROTECTION NETWORK

92C9-29172

Phase Comparators

The phase-comparator signal input (terminal 14) can be direct-coupled provided the signal swing is within CMOS logic levels [logic "0" $\leq 30\%$ ($V_{DD}-V_{SS}$), logic "1" $\geq 70\%$ ($V_{DD}-V_{SS}$)]. For smaller swings the signal must be capacitively coupled to the self-biasing amplifier at the signal input.

Phase comparator I is an exclusive-OR network; it operates analogously to an overdriven balanced mixer. To maximize the lock range, the signal- and comparator-input frequencies must have a 50% duty cycle. With no signal or noise on the signal input, this phase comparator has an average output voltage equal to $V_{DD}/2$. The low-pass filter connected to the output of phase comparator

CD4046B Types

RECOMMENDED OPERATING CONDITIONS at T_A = Full Package-Temperature Range
 For maximum reliability, nominal operating conditions should be selected so that operation is always within the following ranges:

CHARACTERISTIC	LIMITS		UNITS
	Min.	Max.	
Supply-Voltage Range VCO Section: As Fixed Oscillator Phased-Lock-Loop Operation	3	18	V
	5	18	
Supply-Voltage Range Phase Comparator Section: Comparators VCO Operation	3	18	
	5	18	

DESIGN INFORMATION

This information is a guide for approximating the values of external components for the CD4046B in a Phase-Locked-Loop system.

The selected external components must be within the following ranges:
 $5\text{ k}\Omega \leq R_1, R_2, R_S \leq 1\text{ M}\Omega$
 $C_1 \geq 100\text{ pF}$ at $V_{DD} \geq 5\text{ V}$;
 $C_1 \geq 50\text{ pF}$ at $V_{DD} \geq 10\text{ V}$

Characteristics	Phase Comparator Used	Design Information
VCO Frequency	1	VCO WITHOUT OFFSET $R_2 = \infty$
	2	VCO WITH OFFSET
For No. Signal Input	1	Same as for No. 1
	2	VCO will adjust to lowest operating frequency, f_{min}
Frequency Lock Range, $2f_L$	1	$2f_L = \text{full VCO frequency range}$ $2f_L = f_{max} - f_{min}$
	2	Same as for No. 1
Frequency Capture Range, $2f_C$	1	$2f_C \approx \frac{1}{\pi\sqrt{\tau_1}}$
	2	
Loop Filter Component Selection	1	
	2	$f_C = f_L$
Phase Angle Between Signal and Comparator	1	90° at center frequency (f_0) approximating 0° and 180° at ends of lock range ($2f_L$)
	2	Always 0° in lock
Locks On Harmonic of Center Frequency	1	Yes
	2	No
Signal Input Noise Rejection	1	High
	2	Low

For further information, see

- (1) F. Gardner, "Phase-Lock Techniques" John Wiley and Sons, New York, 1966
- (2) G. S. Moschytz, "Miniaturized RC Filters Using Phase-Locked Loop", BSTJ, May, 1965.

I supplies the averaged voltage to the VCO input, and causes the VCO to oscillate at the center frequency (f_0).

The frequency range of input signals on which the PLL will lock if it was initially out of lock is defined as the frequency capture range ($2f_C$).

The frequency range of input signals on which the loop will stay locked if it was initially in lock is defined as the frequency lock range ($2f_L$). The capture range is \leq the lock range.

With phase comparator I the range of frequencies over which the PLL can acquire lock (capture range) is dependent on the low-pass-filter characteristics, and can be made as large as the lock range. Phase-comparator I enables a PLL system to remain in lock in spite of high amounts of noise in the input signal.

One characteristic of this type of phase comparator is that it may lock onto input frequencies that are close to harmonics of the VCO center-frequency. A second characteristic is that the phase angle between the signal and the comparator input varies between 0° and 180° , and is 90° at the center frequency. Fig. 2 shows the typical, triangular, phase-to-output response characteristic of phase-comparator I. Typical waveforms for a CMOS phase-locked-loop employing phase comparator I in locked condition of f_0 is shown in Fig. 3.

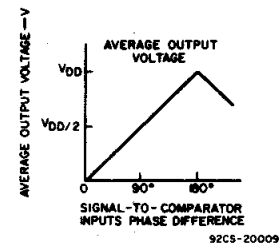

Fig. 2 - Phase-comparator I characteristics at low-pass filter output.

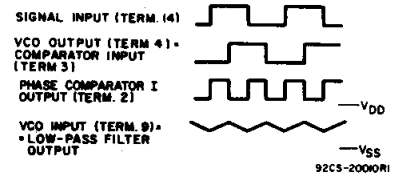

Fig. 3 - Typical waveforms for CMOS phase-locked loop employing phase comparator in locked condition of f_0 .

Phase-comparator II is an edge-controlled digital memory network. It consists of four flip-flop stages, control gating, and a three-state output circuit comprising p- and n-type drivers having a common output node. When the p-MOS or n-MOS drivers are ON they pull the output up to V_{DD} or down to V_{SS} , respectively. This type of phase-comparator acts only on the positive edges of the signal and comparator inputs. The duty cycles of the signal and comparator inputs are not important since positive transitions

COMMERCIAL CMOS HIGH VOLTAGE ICs

CD4046B Types

STATIC ELECTRICAL CHARACTERISTICS

CHARACTERISTIC	CONDITIONS			LIMITS AT INDICATED TEMPERATURES (°C)							UNITS
	V _O (V)	V _{IN} (V)	V _{DD} (V)	-55	-40	+85	+125	+25			
								Min.	Typ.	Max.	
VCO Section											
Output Low (Sink) Current I _{OL} Min.	0.4	0.5	5	0.64	0.61	0.42	0.36	0.51	1	—	mA
	0.5	0.10	10	1.6	1.5	1.1	0.9	1.3	2.6	—	
	1.5	0.15	15	4.2	4	2.8	2.4	3.4	6.8	—	
Output High (Source) Current, I _{OH} Min.	4.6	0.5	5	-0.64	-0.61	-0.42	-0.36	-0.51	-1	—	mA
	2.5	0.5	5	-2	-1.8	-1.3	-1.15	-1.6	-3.2	—	
	9.5	0.10	10	-1.6	-1.5	-1.1	-0.9	-1.3	-2.6	—	
	13.5	0.15	15	-4.2	-4	-2.8	-2.4	-3.4	-6.8	—	
Output Voltage: Low-Level, V _{OL} Max.	Term. 4 driving CMOS	0.5	5	0.05			—	0	0.05	V	
		0.10	10	0.05			—	0	0.05		
		0.15	15	0.05			—	0	0.05		
Output Voltage: High-Level, V _{OH} Min.	e.g. Term. 3	0.5	5	4.95			4.95	5	—	V	
		0.10	10	9.95			9.95	10	—		
		0.15	15	14.95			14.95	15	—		
Input Current I _{IN} Max.	—	0.18	18	±0.1	±0.1	±1	±1	—	±10 ⁻⁵	±0.1	μA
Phase Comparator Section											
Total Device Current, I _{DD} Max. Term. 14 open, Term. 5 = V _{DD}	—	0.5	5	0.2			—	0.1	0.2	mA	
	—	0.10	10	1			—	0.5	1		
	—	0.15	15	1.5			—	0.75	1.5		
	—	0.20	20	4			—	2	4		
Term. 14 = V _{SS} or V _{DD} , Term. 5 = V _{DD}	—	0.5	5	20			—	10	20	μA	
	—	0.10	10	40			—	20	40		
	—	0.15	15	80			—	40	80		
	—	0.20	20	160			—	80	160		
Output Low (Sink) Current I _{OL} Min.	0.4	0.5	5	0.64	0.61	0.42	0.36	0.51	1	—	mA
	0.5	0.10	10	1.6	1.5	1.1	0.9	1.3	2.6	—	
	1.5	0.15	15	4.2	4	2.8	2.4	3.4	6.8	—	
Output High (Source) Current I _{OH} Min.	4.6	0.5	5	-0.64	-0.61	-0.42	-0.36	-0.51	-1	—	mA
	2.5	0.5	5	-2	-1.8	-1.3	-1.15	-1.6	-3.2	—	
	9.5	0.10	10	-1.6	-1.5	-1.1	-0.9	-1.3	-2.6	—	
	13.5	0.15	15	-4.2	-4	-2.8	-2.4	-3.4	-6.8	—	
DC-Coupled Signal Input and Comparator Input Voltage Sensitivity	Low Level V _{IL} Max.	0.5,4.5	—	5	1.5			—	—	1.5	V
		1.9	—	10	3			—	—	3	
	High Level V _{IH} Min.	1.5,13.5	—	15	4			—	—	4	
		0.5,4.5	—	5	3.5			3.5	—	—	
	1.9	—	10	7			7	—	—		
	1.5,13.5	—	15	11			11	—	—		

control the PLL system utilizing this type of comparator. If the signal-input frequency is higher than the comparator-input frequency, the p-type output driver is maintained ON most of the time, and both the n and p drivers OFF (3 state) the remainder

of the time. If the signal-input frequency is lower than the comparator-input frequency, the n-type output driver is maintained ON most of the time, and both the n and p drivers OFF (3 state) the remainder of the time. If the signal- and comparator-

input frequencies are the same, but the signal input lags the comparator input in phase, the n-type output driver is maintained ON for a time corresponding to the phase difference. If the signal- and comparator-input frequencies are the same, but

CD4046B Types

STATIC ELECTRICAL CHARACTERISTICS

CHARACTERISTIC	CONDITIONS			LIMITS AT INDICATED TEMPERATURES (°C)							UNITS
	V _O (V)	V _{IN} (V)	V _{DD} (V)	-55	-40	+85	+125	+25			
								Min.	Typ.	Max.	
Phase Comparator Section (cont'd)											
Input Current I _{IN} Max. (except Term.14)	-	0.18	18	±0.1	±0.1	±1	±1	-	±10 ⁻⁵	±0.1	μA
3-State Leakage Current, I _{OUT} Max.	0.18	0.18	18	±0.1	±0.1	±0.2	±0.2	-	±10 ⁻⁵	±0.1	μA

*Limit determined by minimum feasible leakage current measurement for automatic testing.

ELECTRICAL CHARACTERISTICS at T_A = 25°C

CHARACTERISTIC	TEST CONDITIONS	V _{DD} (V)	LIMITS			UNITS	
			Min.	Typ.	Max.		
VCO Section							
Operating Power Dissipation, P _D	f _o = 10 kHz R ₂ = ∞ VCO _{IN} = $\frac{V_{DD}}{2}$	R ₁ = 1 MΩ	5	-	70	140	μW
			10	-	800	1600	
			15	-	3000	6000	
Maximum Operating Frequency f _{max}	C ₁ = 50 pF R ₂ = ∞ VCO _{IN} = V _{DD}	R ₁ = 10 kΩ	5	0.3	0.6	-	MHz
			10	0.6	1.2	-	
			15	0.8	1.6	-	
	C ₁ = 50 pF R ₂ = ∞ VCO _{IN} = V _{DD}	R ₁ = 5 kΩ	5	0.5	0.8	-	
			10	1	1.4	-	
			15	1.4	2.4	-	
Center Frequency (f _o) and Frequency Range (f _{max} - f _{min})	Programmable with external components R1, R2, and C1 See Design Information						
Linearity	VCO _{IN} = 2.5 V ± 0.3V, R ₁ = 10 kΩ		5	-	1.7	-	%
	= 5 V ± 1 V, = 100 kΩ		10	-	0.5	-	
	= 5 V ± 2.5 V, = 400 kΩ		10	-	4	-	
	= 7.5 V ± 1.5 V, = 100 kΩ		15	-	0.5	-	
Temperature-Frequency Stability: No Frequency Offset f _{MIN} = 0			5	-	±0.12	-	%°C
			10	-	±0.04	-	
Frequency Offset f _{MIN} ≠ 0			5	-	±0.09	-	
			10	-	±0.07	-	
			15	-	±0.03	-	
Output Duty Cycle			5,10,15	-	50	-	%
Output Transition Times, t _{THL} , t _{TLH}			5	-	100	200	ns
			10	-	50	100	
			15	-	40	80	

the comparator input lags the signal in phase, the p-type output driver is maintained ON for a time corresponding to the phase difference. Subsequently, the capacitor voltage of the low-pass filter connected to this phase comparator is adjusted until the signal and comparator inputs are equal in both phase and frequency. At this stable point both p- and n-type output drivers remain OFF and thus the phase comparator output becomes an open circuit and holds the voltage on the capacitor of the low-pass filter constant. Moreover the signal at the "phase pulses" output is a high level which can be used for indicating a locked condition. Thus, for phase comparator II, no phase difference exists between signal and comparator input over the full VCO frequency range. Moreover, the power dissipation due to the low-pass filter is reduced when this type of phase comparator is used because both the p- and n-type output drivers are OFF for most of the signal input cycle. It should be noted that the PLL lock range for this type of phase comparator is equal to the capture range, independent of the low-pass filter. With no signal present at the signal input, the VCO is adjusted to its lowest frequency for phase comparator II. Fig. 10 shows typical waveforms for a CMOS PLL employing phase comparator II in a locked condition.

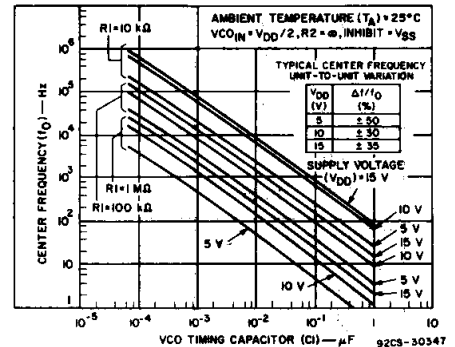

Fig. 4 - Typical center frequency as a function of C1 and R1 at V_{DD} = 5 V, 10 V, and 15 V.

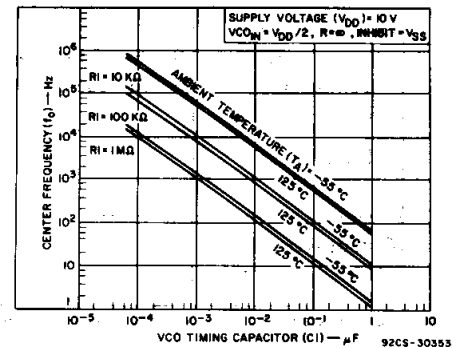

Fig. 5 - Center frequency as a function of C1 and R1 for ambient temperatures of -55°C to 125°C.

3
COMMERCIAL CMOS
HIGH VOLTAGE ICs

CD4046B Types

ELECTRICAL CHARACTERISTICS at $T_A = 25^\circ\text{C}$

CHARACTERISTIC	TEST CONDITIONS	V_{DD} (V)	LIMITS			UNITS
			ALL TYPES			
			Min.	Typ.	Max.	
VCO Section (cont'd)						
Source-Follower Output (Demodulated Output): Offset Voltage $ V_{COIN} - V_{DEM} $	$R_S > 10\text{ k}\Omega$	5 10 15	—	1.8	2.5	V
Linearity	$R_S = 100\text{ k}\Omega$ $= 300\text{ k}\Omega$ $= 500\text{ k}\Omega$	$V_{COIN} = 2.5 \pm 0.3\text{ V}$ $= 5 \pm 2.5\text{ V}$ $= 7.5 \pm 5\text{ V}$	5 10 15	—	0.3 0.7 0.9	— — — %
Zener Diode Voltage (V_Z)	$I_Z = 50\text{ }\mu\text{A}$		4.45	5.5	6.15	V
Zener Dynamic Resistance, R_Z	$I_Z = 1\text{ mA}$		—	40	—	Ω
Phase Comparator Section						
Term. 14 (SIGNAL IN) Input Resistance R_{14}		5 10 15	1 0.2 0.1	2 0.4 0.2	— — —	$M\Omega$
AC Coupled Signal Input Voltage Sensitivity* (peak-to-peak)	$f_{IN} = 100\text{ kHz}$, sine wave	5 10 15	— — —	180 330 900	360 660 1800	mV
Propagation Delay Times, Terms. 14 to 1: High to Low Level, t_{PHL}		5 10 15	— — —	225 100 65	450 200 130	ns
Low to High Level, t_{PLH}		5 10 15	— — —	350 150 100	700 300 200	ns
3-State Propagation Delay Times, Terms. 3 to 13: High Level to High Impedance, t_{PHZ}		5 10 15	— — —	225 100 95	450 200 190	ns
Terms. 14 to 13: Low Level to High Impedance, t_{PLZ}		5 10 15	— — —	285 130 95	570 260 190	ns
Input Rise or Fall Times, t_r , t_f Comparator Input, Term. 3	See Fig. 5 for Phase Comp. II output loading	5 10 15	— — —	— — —	50 1 0.3	μs
Signal Input, Term. 14		5 10 15	— — —	— — —	500 20 2.5	μs
Output Transition Times, t_{THL} , t_{TLH}		5 10 15	— — —	100 50 40	200 100 80	ns

* For sine wave, the frequency must be greater than 10 kHz for Phase Comparator II.

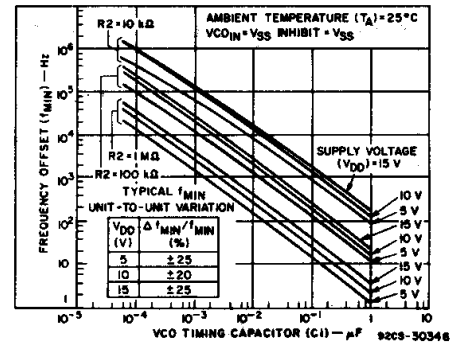

Fig. 6 - Typical frequency offset as a function of C_1 and R_2 for $V_{DD} = 5\text{ V}$, 10 V , and 15 V .

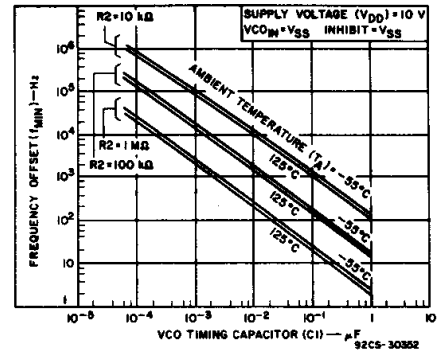

Fig. 7 - Frequency offset as a function of C_1 and R_2 for ambient temperatures of -55°C to 125°C .

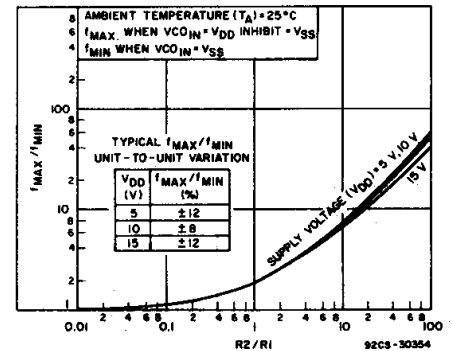

Fig. 8 - Typical f_{MAX}/f_{MIN} as a function of R_2/R_1 .

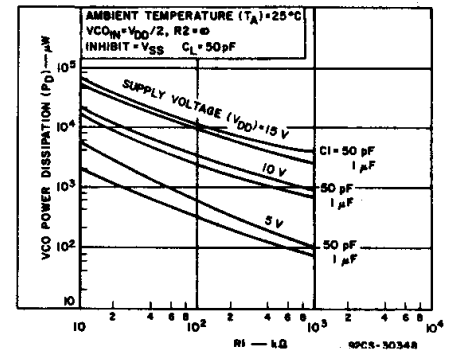

Fig. 9 - Typical VCO power dissipation at center frequency as a function of R_1 .

CD4046B Types

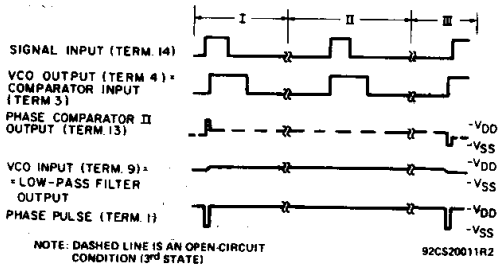

Fig. 10 - Typical waveforms for COS/MOS phase-locked loop employing phase comparator II in locked condition.

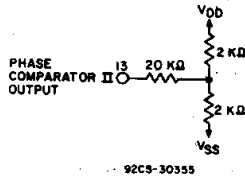

Fig. 11 - Phase comparator II output loading circuit.

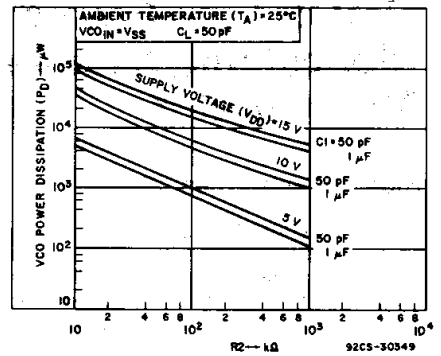

Fig. 12 - Typical VCO power dissipation at f_{MIN} as a function of R_2 .

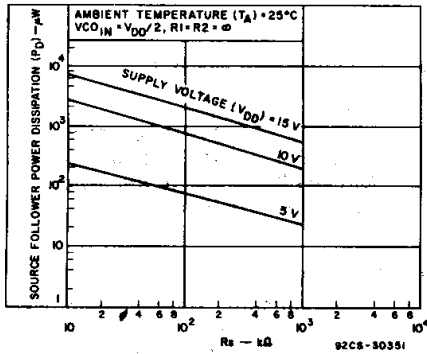

Fig. 13 - Typical source follower power dissipation as a function of R_s .

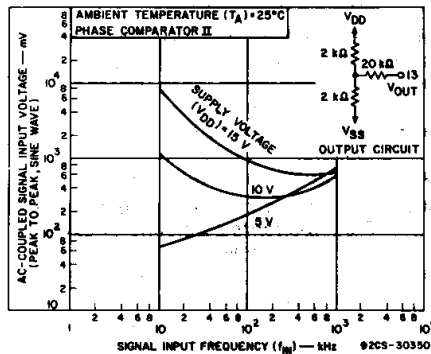

Fig. 14 - AC-coupled signal input voltage as a function of signal input frequency.

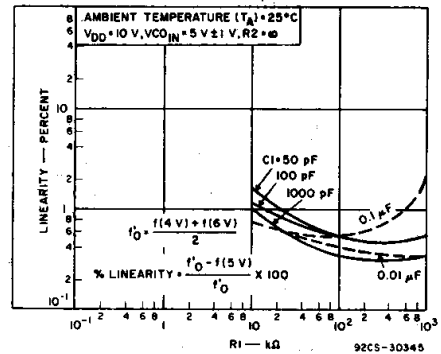

Fig. 15 - Typical VCO linearity as a function of R_1 and C_1 at $V_{DD} = 10$ V.

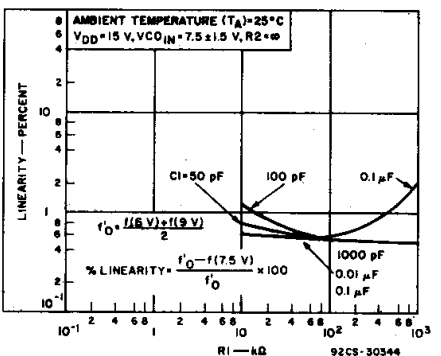
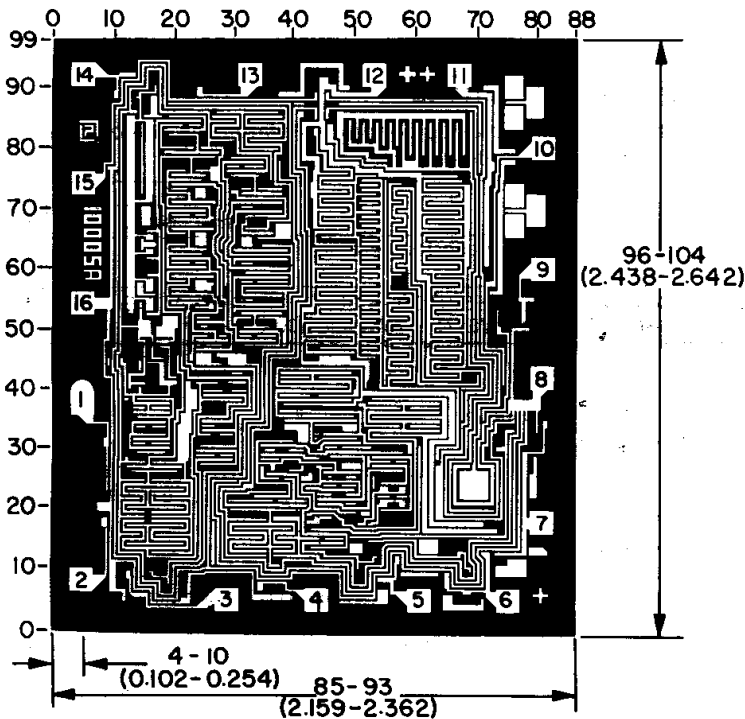

Fig. 16 - Typical VCO linearity as a function of R_1 and C_1 at $V_{DD} = 15$ V.



92CM-36467
Dimensions and pad layout for CD4046BH.

Dimensions in parentheses are in millimeters and are derived from the basic inch dimensions as indicated. Grid graduations are in mils (10^{-3} inch).

3
COMMERCIAL CMOS
HIGH VOLTAGE ICs